

Collaborative Spaces

Effective July 2024 Canada

PRICELIST

collaborative spaces

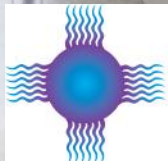

KISIK COMMERCIAL
FURNITURE



Authorized Distributor
Supply Arrangement No. E60PQ-140003/004/PQ
Call: 204-949-0646 or Email: info@kisik.biz

Technical Notes

- All tables are available in HP - High Pressure Laminate (1-1/16" thick) with flat edge.
- Surfaces constructed of 45lb. density particleboard substructure with low pressure laminate or optional high pressure laminate.
- All tables are PVC 3mm edge banded.
- Grommet location must be specified at the time of order or it will default to a no grommet option.
- Power modules and grommets are not included, they must be specified separately.
- Table legs and bases are painted aluminum finish.
- Tables are shipped knocked down and must assembled on site.
- Casters cannot be used with TV Mount units and wire basket for tables larger than 78" long.

DIMENSIONS

Corner radius for small radius table tops is 1.5".

Corner radius for large radius tables tops is 9".

Top end overhang for large tables is 10.5"

Worksurface support beams and footrests (where applicable) are centered for tables 18" and 24" deep.

Worksurface support beams and footrests (where applicable) are 9" from the outside table edges for tables 30" deep.

Worksurface support beams and footrests (where applicable) are 12" from the outside table edges for tables 36 to 48" deep.

GENERAL NOTES

- GREENGUARD certified (www.greenguard.org)
- Carb compliant
- Level3™ certified (www.levelcertified.org)
- Tested to meet or exceed ANSI/BIFMA X5.9.2019 , ANSI/ BIFMA X5.5.2021 and CAN/CGSB 44-227-2008
- Plant is ISO 9001:2015 (Quality) certified
- Plant is ISO 14001: 2015 (Environmental) certified
- Plant is OHSAS 18001:2007 (Health and Safety) certified
- 100% made in Canada
- Lifetime Warranty

STORAGE AND WORKSURFACE FINISHES

Metal Storage Colors - Panel Frame

Matches

Black	BLK
Blizzard	BZD
Charcoal	CHR
Designer White	DWT
Ink	TIN
Nevada	NEV
Silver	SIL
Stonedust	SDT
Taupe	TPE
Tungsten	TUN

PVC Edge Finishes - Panel Frame

Matches

Black	BLK
Blizzard	BZD
Brushed Cobalt	BRC
Charcoal	CHR
Designer White	DWE
Nevada	NEV
Silver	SIL
Stonedust	SDT
Taupe	TPE
Tungsten	TUN

Worksurface PVC Edge Trim - Wood

Grain Matches

Absolute Acajou	AAE	Noce Leggero	NEL
Asian Night	ASE	Noce Medio	NML
Avant Cherry	ACE	Quartered Mahogany	QTM
Avant Honey	AHE	Sheer Beauty	SBY
Clear Maple	CME	Walnut Heights	WHE
Dark Espresso	DEE	White Chocolate	CBE
Fashionista	FAS	Winter Cherry	WCE
First Class	FCL		
Noce Biondo	NBL		
Noce Grigio	NGL		

High Pressure Laminates (HP)

Panel Frame Matches

Black	BLKHP
Blizzard	BZDHP
Brushed Cobalt (Tungsten)	BRCHP
Custom Grey (Silver)	CGYHP
Designer White	DWTHP
Hayden Grey (Taupe)	HGTHP
Stonedust	SDTHP
Storm Grey (Charcoal)	SOGHP
String (Nevada)	STGHP

High Pressure Laminates (HP)

Solids and Patterns

Blizzard Matrix	BMXHP
Grey Matrix	GRXHP
Hayden Linen	HLNHP
Stone Linen	SLNHP
Studio White Matrix	SWXHP

High Pressure Laminates (HP) Wood

Grain Laminates

Absolute Acajou	ACJHP	Noce Leggero	NELHP
Asian Night	ASNHP	Noce Medio	NMLHP
Avant Cherry	AWCHP	Quartered Mahogany	QTMHP
Avant Honey	AWHHP	Sheer Beauty	SBYHP
Clear Maple	CMBHP	Walnut Heights	WHEHP
Dark Espresso	DESHP	White Chocolate	WHCHP
Fashionista	FASHP	Winter Cherry	WCRHP
First Class	FCLHP		
Noce Biondo	NBLHP		
Noce Grigio	NGLHP		

Caster Finish

Black	BLK
Grey	GRC

Grommet Locations

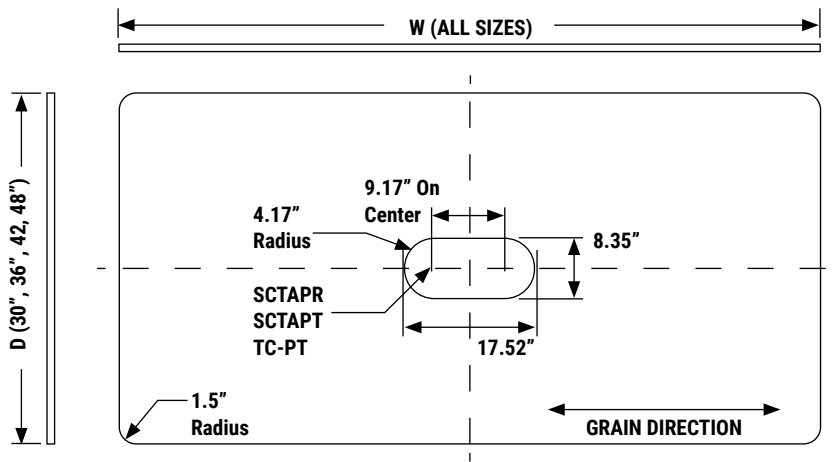

- NOTES:**
1. Cutout not available for 18" and 24" Deep Tables.
 2. Cutout Position TC available only.
 3. These rules apply to both Small and Large Radius Table Tops. Small Radius Top Shown.

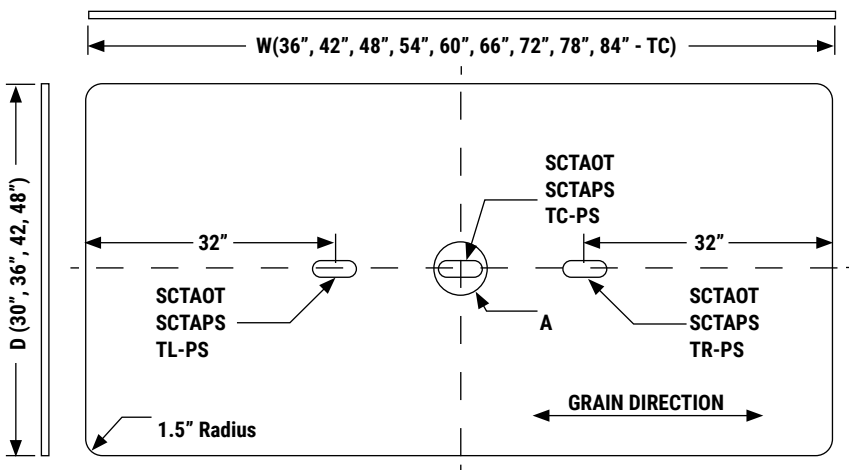

- NOTES:**
1. Cutout not available for 18" and 24" Deep Tables.
 2. SCTAOT/SCTAPS/TL TR Available only for 90" & 96" WIDE TABLES.
 3. These rules apply to both Small and Large Radius Table Tops. Small Radius Top Shown.

Spaces Collaborative Specifications

HOW TO SPECIFY :

Example: SCTWSL2472

SC	Space Collaborative	
T	Table	
W	Work Height Table - 29"	Other Options: C - Café Height Table - 36" B - Bar Height Table - 42"
S	Small Radius - 1.5"	Other Options: L - Large Radius - 9"
L	Levelers	Other Options: C - Casters - Available in BLK - Black or GRC - Grey
24	Depth	
72	Width	
HP	HP - High Pressure	

Choose: Laminate Finish
Edging
Paint
Grommet location as per chart

SCTWD • Core Collaboration Table, 29" Work Height, Small Radius, Levelers

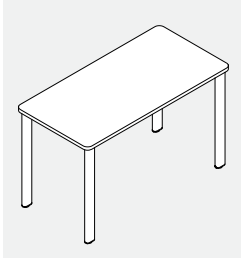

- Core Work Height Collaboration Tables on levelers consist of four individual legs and one surface with a small 1.5" radius at each corner.
- Surface available in HP - High Pressure laminates.
- Legs are painted extruded aluminum. Levelers have 1" adjustment for leveling.
- Tables from 48" to 72" include a center worksurface support beam
- Center worksurface support beam eliminates the possibility of a grommet cutout.

PRODUCT CODE	PRICE HP	SIZE/INCHES			WEIGHT LBS	VOL FT ³
		H	W	D		
SCTWD1848	771	29	48	18	47.06	2.71
SCTWD1854	815	29	54	18	50.88	2.90
SCTWD1860	896	29	60	18	54.70	3.08
SCTWD1866	946	29	66	18	58.52	3.27
SCTWD1872	997	29	72	18	62.34	3.46
SCTWD3048	945	29	48	30	62.98	4.51
SCTWD3054	1010	29	54	30	68.78	4.83
SCTWD3060	1134	29	60	30	74.59	5.14
SCTWD3066	1207	29	66	30	80.40	5.45
SCTWD3072	1280	29	72	30	86.20	5.76

SCTWSL • Standard Collaboration Table, 29" Work Height, Small Radius, Levelers

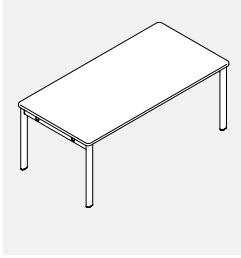

- Work Height Collaboration Tables on levelers consist of two leg assemblies, worksurface support beams and one worksurface with a small 1.5" radius at each corner.
- Surface available in HP - High Pressure laminates.
- Legs are painted extruded aluminum. Levelers have 1" adjustment for leveling.
- Cutouts for power modules are limited to specific sizes/configurations, please see Grommet Location Chart.
- 18" deep tables feature one worksurface support beam.
- 30" deep tables feature two worksurface support beams.

PRODUCT CODE	PRICE HP	SIZE/INCHES			WEIGHT LBS	VOL FT ³
		H	W	D		
SCTWSL1848	1235	29	48	18	50.15	2.71
SCTWSL1854	1272	29	54	18	53.75	2.90
SCTWSL1860	1331	29	60	18	57.34	3.08
SCTWSL1866	1368	29	66	18	60.93	3.27
SCTWSL1872	1443	29	72	18	64.52	3.46
SCTWSL1878	1480	29	78	18	68.12	3.65
SCTWSL1884	1517	29	84	18	71.71	3.83
SCTWSL1890	1628	29	90	18	75.31	4.02
SCTWSL1896	1665	29	96	18	78.90	4.21
SCTWSL3048	1641	29	48	30	56.15	4.51
SCTWSL3054	1698	29	54	30	59.75	4.83
SCTWSL3060	1800	29	60	30	63.34	5.14
SCTWSL3066	1857	29	66	30	66.93	5.45
SCTWSL3072	1988	29	72	30	70.52	5.76
SCTWSL3078	2064	29	78	30	74.12	6.08
SCTWSL3084	2121	29	84	30	77.71	6.70
SCTWSL3090	2326	29	90	30	81.31	6.39
SCTWSL3096	2383	29	96	30	84.90	7.01

SCTCSL • Standard Collaboration Table, 36" Café Height, Small Radius, Levelers

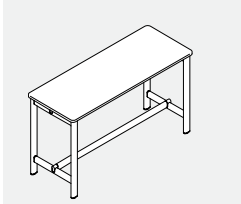

For 18" deep surfaces

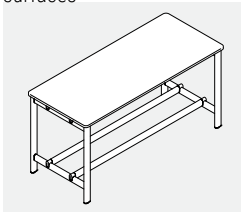

For 30" deep tables, 36" to 72" wide



For 30" deep tables, 78" to 96" wide

- Café Height Collaboration Tables on levelers consist of two leg assemblies, worksurface support beam(s), footrest(s) and one worksurface with a small 1.5" radius at each corner.
- Surface available in HP - High Pressure laminates.
- Legs are painted extruded aluminum.
- Levelers have 1" adjustment for leveling.
- Cutouts for power modules are limited to specific sizes/configurations, please see Grommet Location Chart.
- Tables 18" deep feature one worksurface support beam and one footrest.
- Tables 30" deep feature two worksurface support beams and two footrests.
- Tables 30" deep and 78" wide and greater include a reinforcement cantilever for added stability.

PRODUCT CODE	PRICE HP	SIZE/INCHES			WEIGHT LBS	VOL FT ³
		H	W	D		
SCTCSL1848	1645	36	48	18	61.46	2.71
SCTCSL1854	1682	36	54	18	65.66	2.90
SCTCSL1860	1764	36	60	18	69.87	3.08
SCTCSL1866	1801	36	66	18	74.07	3.27
SCTCSL1872	1912	36	72	18	78.28	3.46
SCTCSL1878	1949	36	78	18	82.48	3.65
SCTCSL1884	1987	36	84	18	86.69	3.83
SCTCSL1890	2171	36	90	18	90.90	4.02
SCTCSL1896	2208	36	96	18	95.10	4.21
SCTCSL3048	2239	36	48	30	107.70	4.51
SCTCSL3054	2296	36	54	30	117.05	4.83
SCTCSL3060	2442	36	60	30	126.41	5.14
SCTCSL3066	2499	36	66	30	135.76	5.45
SCTCSL3072	2704	36	72	30	145.11	5.76
SCTCSL3078	2906	36	78	30	156.91	6.08
SCTCSL3084	2964	36	84	30	166.26	6.70
SCTCSL3090	3316	36	90	30	175.62	6.39
SCTCSL3096	3373	36	96	30	184.97	7.01

SCTBSL • Standard Collaboration Table, 42" Bar Height, Small Radius, Levelers

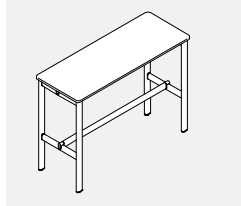

For 18" deep surfaces

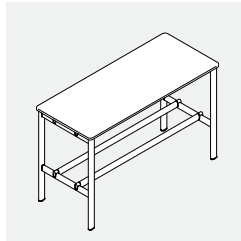

For 30" deep tables, 36" to 72" wide



For 30" deep tables, 78" to 96" wide

- Bar Height Collaboration Tables on levelers consist of two leg assemblies, worksurface support beam(s), footrest(s) and one worksurface with a small 1.5" radius at each corner.
- Surface available in HP - High Pressure laminates.
- Legs are painted extruded aluminum. Levelers have 1" adjustment for leveling.
- Cutouts for power modules are limited to specific sizes/configurations, please see Grommet Location Chart.
- Tables 18" deep feature one worksurface support beam and one footrest.
- Tables 30" deep feature two worksurface support beams and two footrests.
- Tables 30" deep and 78" wide and greater include a reinforcement cantilever for added stability.

PRODUCT CODE	PRICE HP	SIZE/INCHES			WEIGHT LBS	VOL FT ³
		H	W	D		
SCTBSL1848	1746	42	48	18	63.90	2.71
SCTBSL1854	1784	42	54	18	68.11	2.90
SCTBSL1860	1865	42	60	18	72.31	3.08
SCTBSL1866	1902	42	66	18	76.52	3.27
SCTBSL1872	2013	42	72	18	80.72	3.46
SCTBSL1878	2050	42	78	18	84.93	3.65
SCTBSL1884	2088	42	84	18	89.13	3.83
SCTBSL1890	2272	42	90	18	93.34	4.02
SCTBSL1896	2310	42	96	18	97.55	4.21
SCTBSL3048	2340	42	48	30	110.14	4.51
SCTBSL3054	2397	42	54	30	117.05	4.83
SCTBSL3060	2543	42	60	30	126.41	5.14
SCTBSL3066	2600	42	66	30	135.76	5.45
SCTBSL3072	2805	42	72	30	145.11	5.76
SCTBSL3078	3008	42	78	30	159.35	6.08
SCTBSL3084	3065	42	84	30	168.71	6.70
SCTBSL3090	3417	42	90	30	178.06	6.39
SCTBSL3096	3474	42	96	30	187.41	7.01

SCTSWSL • Workshop Table, 29" Work Height, Small Radius, Levelers

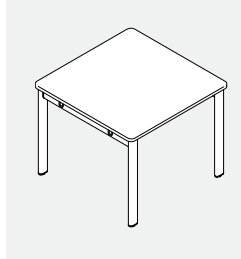

- Work Height Workshop Tables on levelers consist of two leg assemblies, two worksurface support beams and a one worksurface with a small 1.5" radius at each corner.
- Surface available in HP - High Pressure laminates.
- Legs are painted extruded aluminum. Levelers have 1" adjustment for leveling.
- Cutouts for power modules are limited to specific sizes/configurations, please see Grommet Location Chart.

PRODUCT CODE	PRICE HP	SIZE/INCHES			WEIGHT LBS	VOL FT ³
		H	W	D		
SCTSWSL3636	1377	29	36	36	79.31	4.67
SCTSWSL3642	1555	29	42	36	88.83	5.04
SCTSWSL3648	1756	29	48	36	101.24	5.42
SCTSWSL3654	1824	29	54	36	110.76	5.79
SCTSWSL3660	1935	29	60	36	120.27	6.17
SCTSWSL4242	1609	29	42	42	99.72	5.88
SCTSWSL4248	1865	29	48	42	113.52	6.32
SCTSWSL4254	1942	29	54	42	124.41	6.76
SCTSWSL4260	2064	29	60	42	135.31	7.19
SCTSWSL4848	1982	29	48	48	125.80	7.22
SCTSWSL4854	2069	29	54	48	138.07	7.72
SCTSWSL4860	2201	29	60	48	150.35	8.22

SCTSWSC • Workshop Table, 29" Work Height, Small Radius, Casters

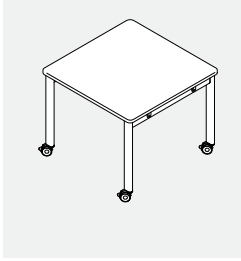

- Work Height Workshop Tables on casters consist of two leg assemblies, two worksurface support beams and a one worksurface with a small 1.5" radius at each corner.
- Surface available in HP - High Pressure laminates.
- Legs are painted extruded aluminum. Casters are lockable, in a choice of two finishes.
- Cutouts for power modules are limited to specific sizes/configurations, please see Grommet Location Chart.

PRODUCT CODE	PRICE HP	SIZE/INCHES			WEIGHT LBS	VOL FT³
		H	W	D		
SCTSWSC3636	1593	29	36	36	79.40	4.67
SCTSWSC3642	1727	29	42	36	88.92	5.04
SCTSWSC3648	1928	29	48	36	101.33	5.42
SCTSWSC3654	1996	29	54	36	110.85	5.79
SCTSWSC3660	2107	29	60	36	120.36	6.17
SCTSWSC4242	1825	29	42	42	99.81	5.88
SCTSWSC4248	2037	29	48	42	113.61	6.32
SCTSWSC4254	1942	29	54	42	124.50	6.76
SCTSWSC4260	2236	29	60	42	135.40	7.19
SCTSWSC4848	2154	29	48	48	125.89	7.22
SCTSWSC4854	2241	29	54	48	138.16	7.72
SCTSWSC4860	2373	29	60	48	150.44	8.22

SCTSWSX • Workshop Table, 29" Work Height, Small Radius, Casters/Levelers

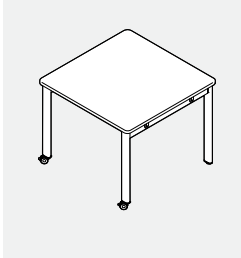

- Work Height Workshop Tables consist of one leg assembly with casters, one leg assembly with levelers, two worksurface support beams and a one worksurface with a small 1.5" radius at each corner.
- Surface available in HP - High Pressure laminates.
- Legs are painted extruded aluminum. Levelers have 1" adjustment for leveling. Casters are lockable, in a choice of 2 finishes.
- Cutouts for power modules are limited to specific sizes/configurations, please see Grommet Location Chart.

PRODUCT CODE	PRICE HP	SIZE/INCHES			WEIGHT LBS	VOL FT³
		H	W	D		
SCTSWSX3636	1485	29	36	36	79.36	4.67
SCTSWSX3642	1619	29	42	36	88.87	5.04
SCTSWSX3648	1842	29	48	36	101.29	5.42
SCTSWSX3654	1910	29	54	36	110.80	5.79
SCTSWSX3660	2021	29	60	36	120.31	6.17
SCTSWSX4242	1717	29	42	42	99.77	5.88
SCTSWSX4248	1951	29	48	42	113.56	6.32
SCTSWSX4254	2028	29	54	42	124.46	6.76
SCTSWSX4260	2150	29	60	42	135.36	7.19
SCTSWSX4848	2068	29	48	48	125.71	7.22
SCTSWSX4854	2155	29	54	48	137.99	7.72
SCTSWSX4860	2287	29	60	48	150.27	8.22

SCTLWSL • Large Collaboration Table, 29" Work Height, Small Radius, Levelers

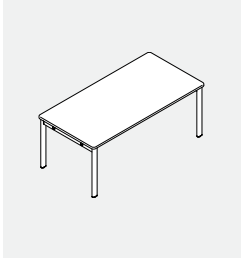

- Large Work Height Collaboration Tables on levelers consist of two leg assemblies, two worksurface support beams and a one worksurface with a small 1.5" radius at each corner.
- Surface available in HP - High Pressure laminates.
- Legs are painted extruded aluminum. Levelers have 1" adjustment for leveling.
- Cutouts for power modules are limited to specific sizes/configurations, please see Grommet Location Chart.

PRODUCT CODE	PRICE HP	SIZE/INCHES			WEIGHT LBS	VOL FT³
		H	W	D		
SCTLWSL3666	2003	29	66	36	129.78	6.54
SCTLWSL3672	2144	29	72	36	139.30	6.92
SCTLWSL3678	2229	29	78	36	148.81	7.29
SCTLWSL3684	2297	29	84	36	158.32	7.67
SCTLWSL3690	2512	29	90	36	167.84	8.04
SCTLWSL3696	2579	29	96	36	177.35	8.42
SCTLWSL4266	2141	29	66	42	146.21	7.63
SCTLWSL4272	2293	29	72	42	127.10	8.07
SCTLWSL4278	2388	29	78	42	168.00	8.51
SCTLWSL4284	2466	29	84	42	178.89	8.94
SCTLWSL4290	2690	29	90	42	189.79	9.38
SCTLWSL4296	2768	29	96	42	200.68	9.82
SCTLWSL4866	2288	29	66	48	162.63	8.72
SCTLWSL4872	2450	29	72	48	174.91	9.22
SCTLWSL4878	2555	29	78	48	187.18	9.72
SCTLWSL4884	2643	29	84	48	199.46	10.22
SCTLWSL4890	2878	29	90	48	211.74	10.72
SCTLWSL4896	2965	29	96	48	224.01	11.22

SCTLWLL • Large Collaboration Table, 29" Work Height, Large Radius, Levelers

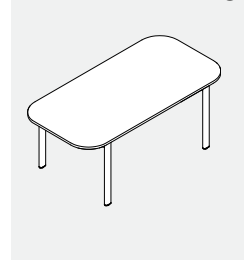

- Large Work Height Collaboration Tables on levelers consist of two leg assemblies, two worksurface support beams and a one worksurface with a large 9" radius at each corner with 10.5" overhang on each end.
- Surface available in HP - High Pressure laminates.
- Legs are painted extruded aluminum. Levelers have 1" adjustment for leveling.
- Cutouts for power modules are limited to specific sizes/configurations, please see Grommet Location Chart.
- Note: Large radius tables are not compatible with SCTAMxx and SCTAMTxx Media Units.

PRODUCT CODE	PRICE HP	SIZE/INCHES			WEIGHT LBS	VOL FT ³
		H	W	D		
SCTLWLL3666	1958	29	66	36	123.52	6.54
SCTLWLL3672	2026	29	72	36	133.03	6.92
SCTLWLLSL678	2137	29	78	36	142.55	7.29
SCTLWLL3684	2205	29	84	36	152.06	7.67
SCTLWLL3690	2346	29	90	36	161.57	8.04
SCTLWLL3696	2431	29	96	36	171.09	8.42
SCTLWLL4266	2097	29	66	42	139.94	7.63
SCTLWLL4272	2175	29	72	42	150.84	8.07
SCTLWLL4278	2296	29	78	42	161.73	8.51
SCTLWLL4284	2374	29	84	42	172.63	8.94
SCTLWLL4290	2525	29	90	42	183.52	9.38
SCTLWLL4296	2599	29	96	42	194.42	9.82
SCTLWLL4866	2244	29	66	48	156.37	8.72
SCTLWLL4872	2332	29	72	48	168.64	9.22
SCTLWLL4878	2463	29	78	48	180.92	9.72
SCTLWLL4884	2551	29	84	48	193.20	10.22
SCTLWLL4890	2712	29	90	48	205.48	10.72
SCTLWLL4896	2818	29	96	48	217.75	11.22

SCTLWSC • Large Collaboration Table, 29" Work Height, Small Radius, Casters

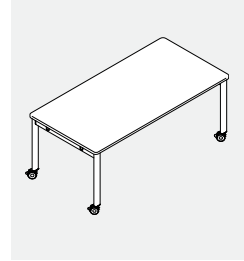

- Large Work Height Collaboration Tables on casters consist of two leg assemblies, two worksurface support beams and a one worksurface with a small 1.5" radius at each corner.
- Surface available in HP - High Pressure laminates.
- Legs are painted extruded aluminum. Casters are lockable, in a choice of two finishes.
- Cutouts for power modules are limited to specific sizes/configurations, please see Grommet Location Chart.

PRODUCT CODE	PRICE HP	SIZE/INCHES			WEIGHT LBS	VOL FT ³
		H	W	D		
SCTLWSC3666	2175	29	66	36	129.87	6.54
SCTLWSC3672	2316	29	72	36	139.39	6.92
SCTLWSC3678	2401	29	78	36	148.90	7.29
SCTLWSC3684	2469	29	84	36	158.41	7.67
SCTLWSC3690	2683	29	90	36	167.93	8.04
SCTLWSC3696	2751	29	96	36	177.44	8.42
SCTLWSC4266	2313	29	66	42	146.30	7.63
SCTLWSC4272	2464	29	72	42	157.19	8.07
SCTLWSC4278	2560	29	78	42	168.09	8.51
SCTLWSC4284	2637	29	84	42	178.98	8.94
SCTLWSC4290	2862	29	90	42	189.88	9.38
SCTLWSC4296	2747	29	96	42	200.77	9.82
SCTLWSC4866	2460	29	66	48	162.72	8.72
SCTLWSC4872	2621	29	72	48	175.00	9.22
SCTLWSC4878	2727	29	78	48	187.27	9.72
SCTLWSC4884	2815	29	84	48	199.55	10.22
SCTLWSC4890	3050	29	90	48	211.83	10.72
SCTLWSC4896	3137	29	96	48	224.10	11.22

SCTLWLC • Large Collaboration Table, 29" Work Height, Large Radius, Casters

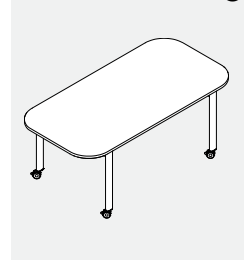

- Large Work Height Collaboration Tables on casters consist of two leg assemblies, two worksurface support beams and a one worksurface with a large 9" radius at each corner with 10.5" overhang on each end.
- Surface available in HP - High Pressure laminates.
- Legs are painted extruded aluminum. Casters are lockable, in a choice of two finishes.
- Cutouts for power modules are limited to specific sizes/configurations, please see Grommet Location Chart.
- Note: Large radius tables are not compatible with SCTAMxx and SCTAMTxx Media Units.

PRODUCT CODE	PRICE HP	SIZE/INCHES			WEIGHT LBS	VOL FT ³
		H	W	D		
SCTLWLC3666	2130	29	66	36	123.61	6.54
SCTLWLC3672	2198	29	72	36	133.12	6.92
SCTLWLC3678	2309	29	78	36	142.64	7.29
SCTLWLC3684	2377	29	84	36	152.15	7.67
SCTLWLC3690	2518	29	90	36	161.66	8.04
SCTLWLC3696	2603	29	96	36	171.18	8.42
SCTLWLC4266	2269	29	66	42	140.03	7.63
SCTLWLC4272	2346	29	72	42	150.93	8.07
SCTLWLC4278	2468	29	78	42	161.82	8.51
SCTLWLC4284	2545	29	84	42	172.72	8.94
SCTLWLC4290	2697	29	90	42	183.62	9.38
SCTLWLC4296	2792	29	96	42	194.51	9.82
SCTLWLC4866	2416	29	66	48	156.46	8.72
SCTLWLC4872	2503	29	72	48	168.73	9.22
SCTLWLC4878	2635	29	78	48	181.01	9.72
SCTLWLC4884	2723	29	84	48	193.29	10.22
SCTLWLC4890	2884	29	90	48	205.57	10.72
SCTLWLC4896	2989	29	96	48	217.84	11.22

SCTSCSL • Workshop Table, 36" Café Height, Small Radius, Levelers



- Café Height Workshop Tables on levelers consist of two leg assemblies, two worksurface support beams, dual footrests and a one worksurface with a small 1.5" radius at each corner.
- Surface available in HP - High Pressure laminates.
- Legs are painted extruded aluminum. Levelers have 1" adjustment for leveling.
- Cutouts for power modules are limited to specific sizes/ configurations, please see Grommet Location Chart.

PRODUCT CODE	PRICE HP	SIZE/INCHES			WEIGHT LBS	VOL FT ³
		H	W	D		
SCTSCSL3636	1959	36	36	36	96.82	5.67
SCTSCSL3642	2159	36	42	36	107.56	6.21
SCTSCSL3648	2382	36	48	36	121.20	6.75
SCTSCSL3654	2450	36	54	36	131.93	7.29
SCTSCSL3660	2605	36	60	36	142.67	7.83
SCTSCSL4242	2236	36	42	42	119.68	7.05
SCTSCSL4248	2512	36	48	42	134.70	7.65
SCTSCSL4254	2589	36	54	42	146.81	8.26
SCTSCSL4260	2755	36	60	42	158.93	8.86
SCTSCSL4848	2658	36	48	48	148.20	8.56
SCTSCSL4854	2746	36	54	48	161.70	9.22
SCTSCSL4860	2922	36	60	48	175.20	9.89

SCTSCSC • Workshop Table, 36" Café Height, Small Radius, Casters

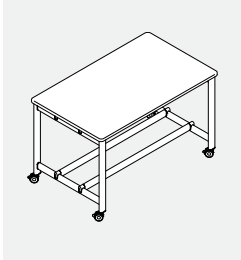

- Café Height Workshop Tables on casters consist of two leg assemblies, two worksurface support beams, dual footrests and a one worksurface with a small 1.5" radius at each corner.
- Surface available in HP - High Pressure laminates.
- Legs are painted extruded aluminum. Casters are lockable, in a choice of two finishes.
- Cutouts for power modules are limited to specific sizes/ configurations, please see Grommet Location Chart.

PRODUCT CODE	PRICE HP	SIZE/INCHES			WEIGHT LBS	VOL FT ³
		H	W	D		
SCTSCSC3636	2155	36	36	36	96.66	5.67
SCTSCSC3642	2355	36	42	36	107.39	6.21
SCTSCSC3648	2579	36	48	36	121.03	6.75
SCTSCSC3654	2646	36	54	36	131.77	7.29
SCTSCSC3660	2802	36	60	36	142.50	7.83
SCTSCSC4242	2475	36	42	42	119.51	7.05
SCTSCSC4248	2708	36	48	42	134.53	7.65
SCTSCSC4254	2786	36	54	42	146.65	8.26
SCTSCSC4296	2952	36	60	42	158.77	8.86
SCTSCSC4848	2855	36	48	48	148.03	8.56
SCTSCSC4854	2942	36	54	48	161.53	9.22
SCTSCSC4860	3118	36	60	48	175.03	9.89

SCTLCSL • Large Collaboration Table, 36" Café Height, Small Radius, Levelers

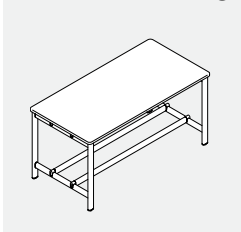

For 66" and 72" wide tables

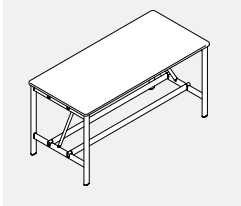

For 78" to 96" wide tables

- Large Café Height Collaboration Tables on levelers consist of two leg assemblies, two worksurface support beams, dual footrests and a one worksurface with a small 1.5" radius at each corner.
- Surface available in HP - High Pressure laminates.
- Legs are painted extruded aluminum. Levelers have 1" adjustment for leveling.
- Cutouts for power modules are limited to specific sizes/ configurations, please see Grommet Location Chart.
- Tables 78" wide and greater include a reinforcement cantilever for added stability.

PRODUCT CODE	PRICE HP	SIZE/INCHES			WEIGHT LBS	VOL FT ³
		H	W	D		
SCTLCSL3666	2673	36	66	36	153.40	8.38
SCTLCSL3672	2888	36	72	36	164.14	8.92
SCTLCSL3678	3100	36	78	36	177.32	9.46
SCTLCSL3684	3168	36	84	36	188.05	10.00
SCTLCSL3690	3530	36	90	36	198.79	10.54
SCTLCSL3696	3597	36	96	36	209.52	11.08
SCTLCSL4266	2832	36	66	42	171.05	9.47
SCTLCSL4272	3057	36	72	42	183.17	10.07
SCTLCSL4278	3280	36	78	42	197.73	10.67
SCTLCSL4284	3358	36	84	42	209.84	11.28
SCTLCSL4290	3730	36	90	42	221.96	11.88
SCTLCSL4296	3807	36	96	42	234.08	12.49
SCTLCSL4866	3009	36	66	48	188.69	10.56
SCTLCSL4872	3244	36	72	48	202.19	11.22
SCTLCSL4878	3477	36	78	48	218.14	11.89
SCTLCSL4884	3564	36	84	48	231.63	12.56
SCTLCSL4890	3947	36	90	48	245.13	13.22
SCTLCSL4896	4034	36	96	48	258.63	13.89

SCTLCLL • Large Collaboration Table, 36" Café Height, Large Radius, Levelers

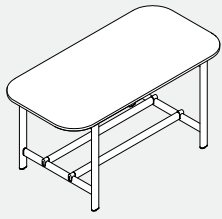

For 66" to 90" wide tables

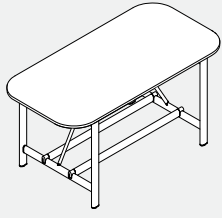

For 96" wide tables

- Large Café Height Collaboration Tables on levelers consist of two leg assemblies, two worksurface support beams and a one worksurface with a large 9" radius at each corner with 10.5" overhang on each end.
- Surface available in HP - High Pressure laminates.
- Legs are painted extruded aluminum. Levelers have 1" adjustment for leveling.
- Cutouts for power modules are limited to specific sizes/configurations, please see Grommet Location Chart.
- Tables 78" wide and greater include a reinforcement cantilever for added stability.
- Note: Large radius tables are not compatible with SCTAMxx and SCTAMTx Media Units.

PRODUCT CODE	PRICE HP	SIZE/INCHES			WEIGHT LBS	VOL FT ³
		H	W	D		
SCTLCLL3666	2584	36	66	36	143.48	8.38
SCTLCLL3672	2652	36	72	36	154.21	8.92
SCTLCLL3678	2807	36	78	36	164.95	9.46
SCTLCLL3684	2875	36	84	36	175.68	10.00
SCTLCLL3690	3090	36	90	36	186.42	10.54
SCTLCLL3696	3302	36	96	36	199.60	11.08
SCTLCLL4266	2744	36	66	42	161.12	9.47
SCTLCLL4272	2821	36	72	42	173.24	10.07
SCTLCLL4278	2987	36	78	42	185.36	10.67
SCTLCLL4284	3065	36	84	42	197.47	11.28
SCTLCLL4290	3290	36	90	42	209.59	11.88
SCTLCLL4296	3165	36	96	42	224.15	12.49
SCTLCLL4866	2921	36	66	48	178.77	10.56
SCTLCLL4872	3008	36	72	48	192.27	11.22
SCTLCLL4878	3184	36	78	48	205.77	11.89
SCTLCLL4884	3271	36	84	48	219.26	12.56
SCTLCLL4890	3506	36	90	48	232.76	13.22
SCTLCLL4896	3739	36	96	48	248.71	13.89

SCTLCSC • Large Collaboration Table, 36" Café Height, Small Radius, Casters

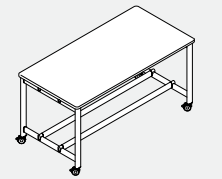

For 66" to 90" wide tables



For 96" wide tables

- Large Café Height Collaboration Tables on casters consist of two leg assemblies, two worksurface support beams, dual footrests and a one worksurface with a small 1.5" radius at each corner.
- Surface available in HP - High Pressure laminates.
- Legs are painted extruded aluminum. Casters are lockable, in a choice of two finishes.
- Cutouts for power modules are limited to specific sizes/configurations, please see Grommet Location Chart.
- Tables 78" wide and greater include a reinforcement cantilever for added stability.

PRODUCT CODE	PRICE HP	SIZE/INCHES			WEIGHT LBS	VOL FT ³
		H	W	D		
SCTLCSC3666	2869	36	66	36	153.24	8.38
SCTLCSC3672	3084	36	72	36	163.97	8.92
SCTLCSC3678	3297	36	78	36	177.15	9.46
SCTLCSC3684	3364	36	84	36	187.89	10.00
SCTLCSC3690	3726	36	90	36	198.62	10.54
SCTLCSC3696	3794	36	96	36	209.36	11.08
SCTLCSC4266	3029	36	66	42	170.88	9.47
SCTLCSC4272	3254	36	72	42	183.00	10.07
SCTLCSC4278	3477	36	78	42	197.56	10.67
SCTLCSC4284	3554	36	84	42	209.68	11.28
SCTLCSC4290	3926	36	90	42	221.80	11.88
SCTLCSC4296	4004	36	96	42	233.91	12.49
SCTLCSC4866	3205	36	66	48	188.53	10.56
SCTLCSC4872	3440	36	72	48	202.03	11.22
SCTLCSC4878	3673	36	78	48	217.97	11.89
SCTLCSC4884	3761	36	84	48	231.47	12.56
SCTLCSC4890	4143	36	90	48	244.97	13.22
SCTLCSC4896	4231	36	96	48	258.47	13.89

SCTLCLC • Large Collaboration Table, 36" Café Height, Large Radius, Casters



For 66" to 90" wide tables

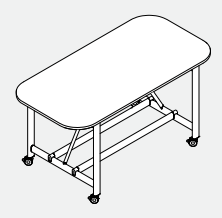

For 96" wide tables

- Large Café Height Collaboration Tables on casters consist of two leg assemblies, two worksurface support beams and a one worksurface with a large 9" radius at each corner with 10.5" overhang on each end.
- Surface available in HP - High Pressure laminates.
- Legs are painted extruded aluminum. Casters are lockable, in a choice of two finishes.
- Cutouts for power modules are limited to specific sizes/configurations, please see Grommet Location Chart.
- Tables 78" wide and greater include a reinforcement cantilever for added stability.
- Note: Large radius tables are not compatible with SCTAMxx and SCTAMTx Media Units.

PRODUCT CODE	PRICE HP	SIZE/INCHES			WEIGHT LBS	VOL FT ³
		H	W	D		
SCTLCLC3666	2781	36	66	36	143.31	8.38
SCTLCLC3672	2848	36	72	36	154.05	8.92
SCTLCLC3678	3004	36	78	36	164.78	9.46
SCTLCLC3684	3071	36	84	36	175.52	10.00
SCTLCLC3690	3286	36	90	36	186.25	10.54
SCTLCLC3696	3499	36	96	36	199.43	11.08
SCTLCLC4266	2940	36	66	42	160.96	9.47
SCTLCLC4272	3018	36	72	42	173.07	10.07
SCTLCLC4278	3184	36	78	42	185.19	10.67
SCTLCLC4284	3261	36	84	42	197.31	11.28
SCTLCLC4290	3486	36	90	42	209.43	11.88
SCTLCLC4296	3709	36	96	42	223.98	12.49
SCTLCLC4866	3117	42	66	48	178.60	10.56
SCTLCLC4872	3204	42	72	48	192.10	11.22
SCTLCLC4878	3380	42	78	48	205.60	11.89
SCTLCLC4884	3468	42	84	48	219.10	12.56
SCTLCLC4890	3703	42	90	48	232.60	13.22
SCTLCLC4896	3936	42	96	48	248.54	13.89

SCTSBSL • Workshop Table, 42" Bar Height, Small Radius, Levelers

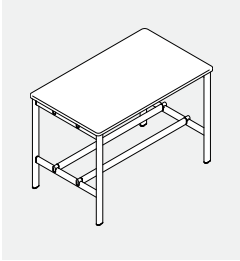

- Bar Height Workshop Tables on levelers consist of two leg assemblies, two worksurface support beams, dual footrests and a one worksurface with a small 1.5" radius at each corner.
- Surface available in HP - High Pressure laminates.
- Legs are painted extruded aluminum. Levelers have 1" adjustment for leveling.
- Cutouts for power modules are limited to specific sizes/configurations, please see Grommet Location Chart.

PRODUCT CODE	PRICE HP	SIZE/INCHES			WEIGHT LBS	VOL FT ³
		H	W	D		
SCTSBSL3636	2060	42	36	36	99.27	5.67
SCTSBSL3642	2260	42	42	36	110.00	6.21
SCTSBSL3648	2483	42	48	36	123.64	6.75
SCTSBSL3654	2551	42	54	36	134.38	7.29
SCTSBSL3660	2707	42	60	36	145.11	7.83
SCTSBSL4242	2379	42	42	42	122.12	7.05
SCTSBSL4248	2613	42	48	42	137.14	7.65
SCTSBSL4254	2690	42	54	42	149.26	8.26
SCTSBSL4260	2856	42	60	42	161.38	8.86
SCTSBSL4848	2759	42	48	48	150.64	8.56
SCTSBSL4854	2847	42	54	48	164.14	9.22
SCTSBSL4860	3023	42	60	48	177.64	9.89

SCTSBSC • Workshop Table, 42" Bar Height, Small Radius, Casters

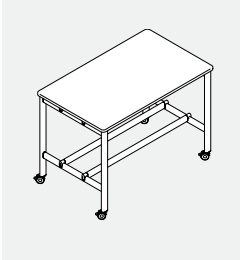

- Bar Height Workshop Tables on casters consist of two leg assemblies, two worksurface support beams, dual footrests and a one worksurface with a small 1.5" radius at each corner.
- Surface available in HP - High Pressure laminates.
- Legs are painted extruded aluminum. Levelers have 1" adjustment for leveling.
- Cutouts for power modules are limited to specific sizes/configurations, please see Grommet Location Chart.

PRODUCT CODE	PRICE HP	SIZE/INCHES			WEIGHT LBS	VOL FT ³
		H	W	D		
SCTSBSC3636	2197	42	36	36	99.10	5.67
SCTSBSC3642	2397	42	42	36	109.84	6.21
SCTSBSC3648	2621	42	48	36	123.48	6.75
SCTSBSC3654	2688	42	54	36	134.21	7.29
SCTSBSC3660	2844	42	60	36	144.95	7.83
SCTSBSC4242	2517	42	42	42	121.95	7.05
SCTSBSC4248	2750	42	48	42	136.98	7.65
SCTSBSC4254	2828	42	54	42	149.09	8.26
SCTSBSC4296	2994	42	60	42	161.21	8.86
SCTSBSC4848	2897	42	48	48	150.47	8.56
SCTSBSC4854	2984	42	54	48	163.97	9.22
SCTSBSC4860	3160	42	60	48	177.47	9.89

SCTLBSL • Large Collaboration Table, 42" Bar Height, Small Radius, Levelers



For 66" and 72" wide tables

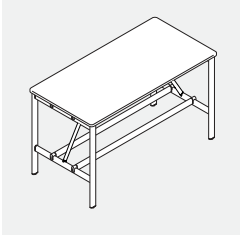

For 78" to 96" wide tables

- Large Bar Height Collaboration Tables on levelers consist of two leg assemblies, two worksurface support beams, dual footrests and a one worksurface with a small 1.5" radius at each corner.
- Surface available in HP - High Pressure laminates.
- Legs are painted extruded aluminum. Levelers have 1" adjustment for leveling.
- Cutouts for power modules are limited to specific sizes/configurations, please see Grommet Location Chart.
- Tables 78" wide and greater include a reinforcement cantilever for added stability.

PRODUCT CODE	PRICE HP	SIZE/INCHES			WEIGHT LBS	VOL FT ³
		H	W	D		
SCTLBSL3666	2774	42	66	36	155.85	8.38
SCTLBSL3672	2989	42	72	36	166.58	8.92
SCTLBSL3678	3224	42	78	36	179.76	9.46
SCTLBSL3684	3291	42	84	36	190.50	10.00
SCTLBSL3690	3653	42	90	36	201.23	10.54
SCTLBSL3696	3721	42	96	36	211.97	11.08
SCTLBSL4266	2934	42	66	42	173.49	9.47
SCTLBSL4272	3158	42	72	42	185.61	10.07
SCTLBSL4278	3403	42	78	42	200.17	10.67
SCTLBSL4284	3481	42	84	42	212.29	11.28
SCTLBSL4290	3853	42	90	42	224.41	11.88
SCTLBSL4296	3931	42	96	42	236.52	12.49
SCTLBSL4866	3110	42	66	48	191.14	10.56
SCTLBSL4872	3345	42	72	48	204.64	11.22
SCTLBSL4878	3600	42	78	48	220.58	11.89
SCTLBSL4884	3687	42	84	48	234.08	12.56
SCTLBSL4890	4070	42	90	48	247.58	13.22
SCTLBSL4896	4157	42	96	48	261.08	13.89

SCTLBLL • Large Collaboration Table, 42" Bar Height, Large Radius, Levelers

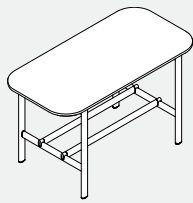

For 66" to 90" wide tables

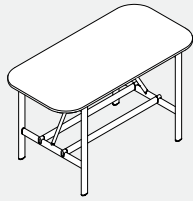

For 96" wide tables

- Large Bar Height Collaboration Tables on levelers consist of two leg assemblies, two worksurface support beams and a one worksurface with a large 9" radius at each corner with 10.5" overhang on each end.
- Surface available in HP - High Pressure laminates.
- Legs are painted extruded aluminum. Levelers have 1" adjustment for leveling.
- Cutouts for power modules are limited to specific sizes/configurations, please see Grommet Location Chart.
- Tables 78" wide and greater include a reinforcement cantilever for added stability.
- Note: Large radius tables are not compatible with SCTAMxx and SCTAMTxx Media Units.

PRODUCT CODE	PRICE HP	SIZE/INCHES			WEIGHT LBS	VOL FT ³
		H	W	D		
SCTLBLL3666	2685	42	66	36	145.92	8.38
SCTLBLL3672	2753	42	72	36	156.66	8.92
SCTLBLL3678	3036	42	78	36	167.39	9.46
SCTLBLL3684	2976	42	84	36	178.13	10.00
SCTLBLL3690	3191	42	90	36	188.86	10.54
SCTLBLL3696	3403	42	96	36	202.04	11.08
SCTLBLL4266	2845	42	66	42	163.57	9.47
SCTLBLL4272	2922	42	72	42	175.68	10.07
SCTLBLL4278	3088	42	78	42	187.80	10.67
SCTLBLL4284	3166	42	84	42	199.92	11.28
SCTLBLL4290	3391	42	90	42	212.04	11.88
SCTLBLL4296	3613	42	96	42	226.60	12.49
SCTLBLL4866	3022	42	66	48	181.21	10.56
SCTLBLL4872	3109	42	72	48	194.71	11.22
SCTLBLL4878	3285	42	78	48	208.21	11.89
SCTLBLL4884	3372	42	84	48	221.71	12.56
SCTLBLL4890	3607	42	90	48	235.21	13.22
SCTLBLL4896	3840	42	96	48	251.15	13.89

SCTLBSC • Large Collaboration Table, 42" Bar Height, Small Radius, Casters

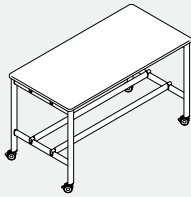

For 66" and 72" wide tables

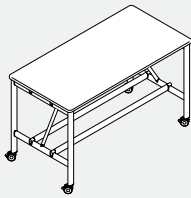

For 78" to 96" wide tables

- Large Bar Height Collaboration Tables on casters consist of two leg assemblies, two worksurface support beams and a one worksurface with a small 1.5" radius at each corner.
- Surface available in HP - High Pressure laminates.
- Legs are painted extruded aluminum. Casters are lockable, in a choice of two finishes.
- Cutouts for power modules are limited to specific sizes/configurations, please see Grommet Location Chart.
- Tables 78" wide and greater include a reinforcement cantilever for added stability.

PRODUCT CODE	PRICE HP	SIZE/INCHES			WEIGHT LBS	VOL FT ³
		H	W	D		
SCTLBSC3666	2911	42	66	36	155.68	8.38
SCTLBSC3672	3126	42	72	36	166.42	8.92
SCTLBSC3678	3361	42	78	36	179.60	9.46
SCTLBSC3684	3428	42	84	36	190.33	10.00
SCTLBSC3690	3791	42	90	36	201.07	10.54
SCTLBSC3696	3858	42	96	36	211.80	11.08
SCTLBSC4266	3071	42	66	42	173.33	9.47
SCTLBSC4272	3296	42	72	42	185.45	10.07
SCTLBSC4278	3541	42	78	42	200.00	10.67
SCTLBSC4284	3618	42	84	42	212.12	11.28
SCTLBSC4290	3991	42	90	42	224.24	11.88
SCTLBSC4296	4068	42	96	42	236.36	12.49
SCTLBSC4866	3248	42	66	48	190.97	10.56
SCTLBSC4872	3483	42	72	48	204.47	11.22
SCTLBSC4878	3737	42	78	48	220.41	11.89
SCTLBSC4884	3825	42	84	48	233.91	12.56
SCTLBSC4890	4207	42	90	48	247.41	13.22
SCTLBSC4896	4295	42	96	48	260.91	13.89

SCTLBLC • Large Collaboration Table, 42" Bar Height, Large Radius, Casters

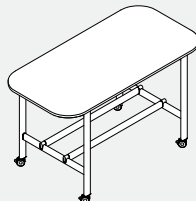

For 66" to 90" wide tables

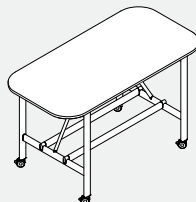

For 96" wide tables

- Large Bar Height Collaboration Tables on casters consist of two leg assemblies, two worksurface support beams and a one worksurface with a large 9" radius at each corner with 10.5" overhang on each end.
- Surface available in HP - High Pressure laminates.
- Legs are painted extruded aluminum. Casters are lockable, in a choice of two finishes.
- Cutouts for power modules are limited to specific sizes/configurations, please see Grommet Location Chart.
- Tables 96" wide include a reinforcement cantilever for added stability.
- Note: Large radius tables are not compatible with SCTAMxx and SCTAMTxx Media Units.

PRODUCT CODE	PRICE HP	SIZE/INCHES			WEIGHT LBS	VOL FT ³
		H	W	D		
SCTLBLC3666	2823	42	66	36	145.75	8.38
SCTLBLC3672	2890	42	72	36	156.49	8.92
SCTLBLC3678	3046	42	78	36	167.23	9.46
SCTLBLC3684	3113	42	84	36	177.96	10.00
SCTLBLC3690	3328	42	90	36	188.70	10.54
SCTLBLC3696	3541	42	96	36	201.87	11.08
SCTLBLC4266	2983	42	66	42	163.40	9.47
SCTLBLC4272	3060	42	72	42	175.52	10.07
SCTLBLC4278	3226	42	78	42	187.63	10.67
SCTLBLC4284	3303	42	84	42	199.75	11.28
SCTLBLC4290	3528	42	90	42	211.87	11.88
SCTLBLC4296	3751	42	96	42	226.43	12.49
SCTLBLC4866	3159	42	66	48	181.04	10.56
SCTLBLC4872	3247	42	72	48	197.54	11.22
SCTLBLC4878	3422	42	78	48	208.04	11.89
SCTLBLC4884	3510	42	84	48	221.54	12.56
SCTLBLC4890	3745	42	90	48	235.04	13.22
SCTLBLC4896	3978	42	96	48	250.98	13.89

SCTAMT • Collaboration Table Media Unit with TV Mount

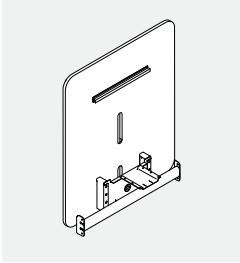

- Collaboration Table Media Unit with TV Mount can be affixed to all small radius tables of the same nominal width. User side is thermally fused laminate and includes a TV mount. Side facing away from users features a tackable PET panel affixed to the thermally fused laminate with a 0.5" inset.
- Surface available in LP - Low Pressure Laminate.
- Felt backer available in all standard finishes.
- Brackets and reinforcement bar is painted metal.
- Units 36" wide can accept TV's up to 40", not exceeding 50 lbs.
- Units 42" wide can accept TV's up to 43", not exceeding 50 lbs.
- Units 48" wide can accept TV's up to 55", not exceeding 50 lbs.

PRODUCT CODE	PRICE LP	SIZE/INCHES			WEIGHT LBS	VOL FT ³
		H	W	D		
SCTAMT36	942	43	36	11.25	47.58	10.08
SCTAMT42	961	43	42	11.25	53.80	11.76
SCTAMT48	1020	43	48	11.25	60.13	13.44

SCTAL • Table Leg Cable Organizer

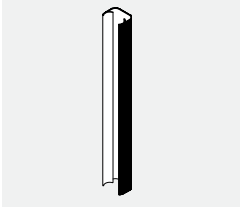

- Table Leg Cable organizer snaps on to any leg to manage wires vertically. Black only.

PRODUCT CODE	PRICE	SIZE/INCHES			WEIGHT LBS	VOL FT ³
		H	W	D		
SCTAL21	29	21	2.965	2.21	0.60	0.09
SCTAL23	33	23	2.965	2.21	0.60	0.09

SCTAP • PET Felt Modesty Panel

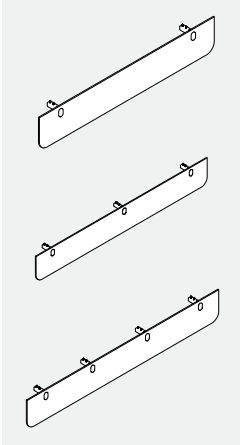

- PET Felt modesty panel with metal brackets for use on Core, Standard and Workshop tables.
- Modesty panels 36" to 54" include two brackets.
- Modesty panels 60" to 90" include three brackets.
- Modesty panels 96" include four brackets.
- Specify matching nominal width to table.
- PET Felt available in standard finishes.

PRODUCT CODE	PRICE	SIZE/INCHES			WEIGHT LBS	VOL FT ³
		H	W	D		
SCTAP36	75	11	33	4.75	1.78	1.00
SCTAP42	81	11	39	4.75	1.99	1.18
SCTAP48	81	11	45	4.75	2.14	1.36
SCTAP54	85	11	51	4.75	2.38	1.54
SCTAP60	114	11	57	4.75	2.53	1.72
SCTAP66	118	11	63	4.75	2.68	1.90
SCTAP72	122	11	69	4.75	2.87	2.09
SCTAP78	126	11	75	4.75	3.05	2.27
SCTAP84	137	11	81	4.75	3.23	2.45
SCTAP90	149	11	87	4.75	3.41	2.63
SCTAP96	162	11	93	4.75	3.59	2.81

SCTAT • Wire Mesh Storage Tray

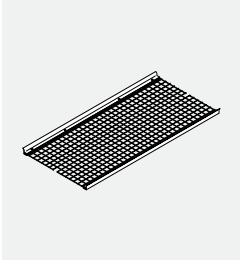

- Steel storage tray is attached between dual stretchers on tables 48"d x 48"w and larger.
- Specify matching nominal width to table.
- Cannot be combined with SCTAM/SCTAMT Media Units on tables on casters.
- Specify matching nominal width to table.

PRODUCT CODE	PRICE	87SIZE/INCHES93			WEIGHT LBS	VOL FT ³
		H	W	D		
SCTAT4848	204	1.6	42	22	7.85	0.98
SCTAT4854	229	1.6	48	22	8.97	1.10
SCTAT4860	260	1.6	54	22	10.09	1.22
SCTAT4866	294	1.6	60	22	11.19	1.34
SCTAT4872	392	1.6	66	22	12.29	1.47
SCTAT4878	403	1.6	72	22	13.40	1.59
SCTAT4884	417	1.6	78	22	14.52	1.71
SCTAT4890	481	1.6	84	22	15.62	1.83
SCTAT4896	495	1.6	90	22	16.72	1.96

SCTAH • Table Mounted Bag Hook

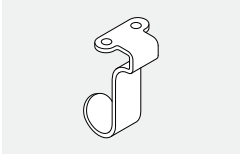

- Steel hook for use on Collaborative tables.
- Specify standard metal paint finish.
- Maximum capacity of 10 lbs.

PRODUCT CODE	PRICE	SIZE/INCHES			WEIGHT LBS	VOL FT ³
		H	W	D		
SCTAH	16	3.5	1.5	0.65	0.30	

SCTAPS • Nik In-Surface Power Module

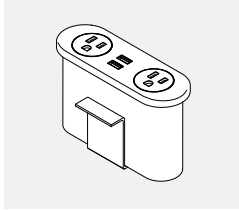

- Nik In-Surface Power Module in black with black receptacles, 10ft cord.
- 2 AC, 1 USB-A 1.5A charge port, 1 USB-A 2.4A quick charge port

PRODUCT CODE	PRICE	SIZE/INCHES			WEIGHT VOL	
		H	W	D	LBS	FT ³
SCTAPSC	578	3.7	6	2.10	4.00	0.03

SCTAPT • Collaborative Spaces Power Tray

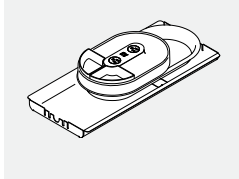

- Black plastic power tray with removable grey accessory trays. Top tray is offset for cable storage underneath. Recessed tray sits 3.7" below surface to keep cables out of sight.
- Specify configuration, last letter of the code represents the following.
- 10ft cord.
- C = 2 AC, 1 USB-A 1.5A charge port, 1 USB-A 2.4A quick charge port

PRODUCT CODE	PRICE	SIZE/INCHES			WEIGHT VOL	
		H	W	D	LBS	FT ³
SCTAPTC	858	4.53	23.26	10.51	7.73	0.64

SCTAOT • Collaborative Spaces Organizer Tray

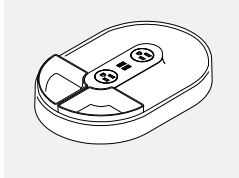

- Black plastic power tray with removable grey accessory trays.
- 10ft cord.
- 2 AC, 1 USB-A 1.5A charge port, 1 USB-A 2.4A quick charge port

PRODUCT CODE	PRICE	SIZE/INCHES			WEIGHT VOL	
		H	W	D	LBS	FT ³
SCTAOTC	639	4.28	12.40	8.32	1.50	0.26

SCTAPR • Collaborative Spaces Recessed Power Tray

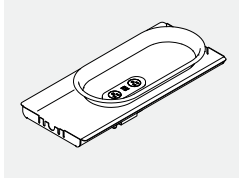

- Black plastic power tray. Recessed tray sits 3.7" below surface to keep cables out of sight.
- 10ft cord.
- 2 AC, 1 USB-A 1.5A charge port, 1 USB-A 2.4A quick charge port

PRODUCT CODE	PRICE	SIZE/INCHES			WEIGHT VOL	
		H	W	D	LBS	FT ³
SCTAPRC	760	6.4	23.26	10.51	6.06	0.91

SCTACT • Collaborative Spaces PET Felt Wire Manager

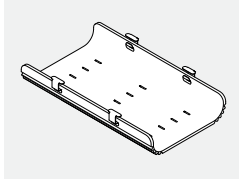

- PET Felt Wire Manager hangs from four brackets under the surface.
- Includes black painted metal brackets.
- PET Felt available in standard finishes.

PRODUCT CODE	PRICE	SIZE/INCHES			WEIGHT VOL	
		H	W	D	LBS	FT ³
SCTACT	80	4	11	26	1.10	0.66

SCCM • Media Cart

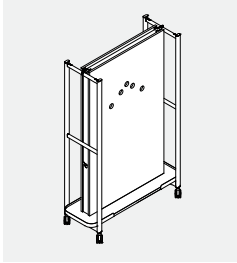

- Media Cart includes a bottom shelf and thermally fused laminate TV board. Short side panels feature small cutout for wire pass thru and hook for wire management.
- Side rails accept compatible accessories.
- Shelf available in LP - Low Pressure laminate.
- Back panel is removeable for access to cavity for cable management. Back panel is whiteboard laminate.
- SCCMEP models include a power bar (SCCAMP) mounted internally.
- SCCMNE models do not include any power.
- Units 48" wide can accept TV's up to 55", not exceeding 50lbs.
- Units 60" wide can accept TV's up to 60", not exceeding 50lbs.
- Painted aluminum frame available in standard paint finishes.
- Casters are lockable, in a choice of two finishes.
- Note: TV mount included. TV and video conferencing units are not included.

PRODUCT CODE	PRICE LP	SIZE/INCHES			WEIGHT		VOL FT ³
		H	W	D	LBS		
SCCMEP1848	3515	72	48	18	171.42		36.04
SCCMEP1860	3945	72	60	18	214.23		45.05
SCCMNE1848	3343	72	48	18	170.92		36.04
SCCMNE1860	3772	72	60	18	213.73		45.05

SCCSW • Single Sided Whiteboard Cart

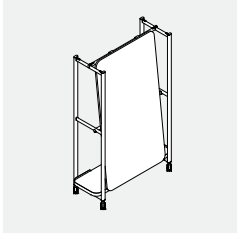

- Cart includes one fixed shelf with metal trim detail, accessible from behind whiteboard.
- Front of vertical whiteboard panel is whiteboard only.
- Side rails accept compatible accessories.
- Back of vertical whiteboard panel is DWTL P - Designer White laminate with DWE - Designer White edging.
- Shelf available in LP - Low Pressure laminate.
- Painted aluminum frame available in standard paint finishes.
- Casters are lockable, in a choice of two finishes.

PRODUCT CODE	PRICE LP	SIZE/INCHES			WEIGHT		VOL FT ³
		H	W	D	LBS		
SCCSW1848	3011	72	48	18	106.37		36.04
SCCSW1860	3531	72	60	18	191.07		45.05

SCCDW • Double Side Whiteboard Cart

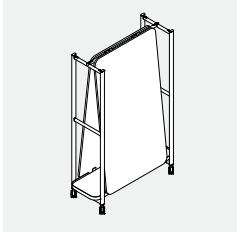

- Cart includes one fixed shelf with metal trim detail, accessible from behind whiteboard.
- Front of vertical whiteboard panels are whiteboard only.
- Side rails accept compatible accessories.
- Back of vertical whiteboard panels are DWTL P - Designer White laminate with DWE - Designer White edging.
- Shelf available in LP - Low Pressure laminate.
- Painted aluminum frame available in standard paint finishes.
- Casters are lockable, in a choice of two finishes.

PRODUCT CODE	PRICE LP	SIZE/INCHES			WEIGHT		VOL FT ³
		H	W	D	LBS		
SCCDW1848	4061	72	48	18	153.96		36.04
SCCDW1860	5027	72	60	18	191.07		45.05

SCCCW • Combo Whiteboard Cart

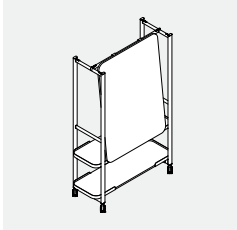

- Cart includes two fixed shelves with metal trim detail. Bottom shelf is accessible from both sides of cart, top shelf accessible from behind whiteboard.
- Front of vertical whiteboard panel is whiteboard only.
- Side rails accept compatible accessories.
- Back of vertical whiteboard panel is DWTL P - Designer White laminate with DWE - Designer White edging.
- Shelves available in LP - Low Pressure laminate.
- Painted aluminum frame available in standard paint finishes.
- Casters are lockable, in a choice of two finishes.

PRODUCT CODE	PRICE LP	SIZE/INCHES			WEIGHT		VOL FT ³
		H	W	D	LBS		
SCCCW1848	3250	72	48	18	115.66		36.04
SCCCW1860	3736	72	60	18	150.33		45.05

SCCAMP • Concealed Power Unit

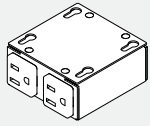

- Provided inside SCCMEPxxxx media units, can be added to SCCNMExxxx in field.
- Includes two AC outlets.
- Compatible with Mobile Media Carts only.
- BLK - Black finish only.

PRODUCT CODE	PRICE	SIZE/INCHES			WEIGHT VOL	
		H	W	D	LBS	FT ³
SCCAMP	251	1.5	3	3.00	0.50	0.01

SCCAMT • Media Tray

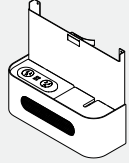

- Attaches to the front of the SCCMEPxxxx/ SCCNMExxxx to provide a wire catch, wireless receiver area and easily accessible power at the front of the media carts.
- Compatible with Mobile Media Carts only.
- Tray is painted metal with a PET Felt insert.
- PET Felt available in 18 standard finishes.
- SCCAMT is empty and has no power capabilities.
- Specify configuration, last letter of the code represents the following:
 - C = 2 AC, 1 USB-A 1.5A charge port, 1 USB-A 2.4A quick charge port
 - D = 1 AC, 1 USB-A 1.5A charge port, 1 USB-A 2.4A quick charge port, 1 60W USB-C charge port
 - E = 3 AC

PRODUCT CODE	PRICE	SIZE/INCHES			WEIGHT VOL	
		H	W	D	LBS	FT ³
SCCAMT	611	13.80	14.57	5.60	12	0.65
SCCAMTPC	1189	13.80	14.57	5.60	12	0.65
SCCAMTPD	1329	13.80	14.57	5.60	12	0.65
SCCAMTPE	1120	13.80	14.57	5.60	12	0.65

SCCAC • Accessory Cup



- Hangs onto any team cart horizontal top or side rail. Black only.

PRODUCT CODE	PRICE	SIZE/INCHES			WEIGHT VOL	
		H	W	D	LBS	FT ³
SCCAC	9	3.7	3.3	3.00	0.15	0.02

SCCAH • Hook for Team Cart



- Hangs onto any team cart horizontal top or side rail.
- Black only
- Maximum capacity of 10 lbs.

PRODUCT CODE	PRICE	SIZE/INCHES			WEIGHT VOL	
		H	W	D	LBS	FT ³
SCCAH	6	1.8	1.3	0.65	0.10	

SCCAL5 • Laptop Shelf

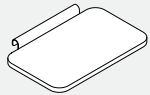

- Laminate laptop shelf with dual bracket.
- Can be flipped vertically to store when cart is not in use.
- Shelf available in LP - Low Pressure laminate.
- Bracket included is painted metal finish and should be specified to match the cart finish.

PRODUCT CODE	PRICE LP	SIZE/INCHES			WEIGHT VOL	
		H	W	D	LBS	FT ³
SCCAL51219	243	3	19	12	11.07	

SCOR • Occasional Side Table, Round Top

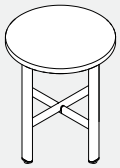

- Occasional End Table includes leg assembly, cross beams and one worksurface.
- Surface available in LP - Low Pressure laminate.
- Legs and cross beam are painted aluminum available in standard paint finishes.

PRODUCT CODE	PRICE LP	SIZE/INCHES			WEIGHT LBS	VOL FT ³
		H	W	D		
SCOR1818	514	21	18	18	18.52	3.94
SCOR2424	584	21	24	24	26.53	7.01

SCOC • Occasional Side Table, Square Top

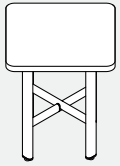

- Occasional End Table includes leg assembly, cross beams and one worksurface with a small 1.5" radius at each corner.
- Surface available in LP - Low Pressure laminate.
- Legs and cross beam are painted aluminum available in standard paint finishes.

PRODUCT CODE	PRICE LP	SIZE/INCHES			WEIGHT LBS	VOL FT ³
		H	W	D		
SCOC1818	514	21	18	18	21.12	3.94
SCOC2424	584	21	24	24	31.20	7.01

SCOCL • Occasional Side Table, Square Top, Larger Radius

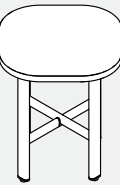

- Occasional End Table includes leg assembly, cross beams and one worksurface with a larger 9" radius at each corner.
- Surface available in LP - Low Pressure laminate.
- Legs and cross beam are painted aluminum available in standard paint finishes.

PRODUCT CODE	PRICE LP	SIZE/INCHES			WEIGHT LBS	VOL FT ³
		H	W	D		
SCOCL1818	550	21	18	18	21.12	3.94
SCOCL2424	648	21	24	24	31.20	7.01

SCOCR • Occasional Coffee Table, Round Top

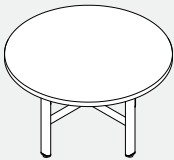

- Occasional End Table includes leg assembly, cross beams and one worksurface.
- Surface available in LP - Low Pressure laminate.
- Legs and cross beam are painted aluminum available in standard paint finishes.

PRODUCT CODE	PRICE LP	SIZE/INCHES			WEIGHT LBS	VOL FT ³
		H	W	D		
SCOCR2424	563	17	24	24	25.55	5.67
SCOCR3030	643	17	30	30	35.76	8.86
SCOCR3636	739	17	36	36	48.13	12.76

SCOCS • Occasional Coffee Table, Square Top

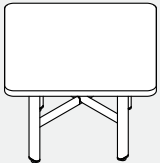

- Occasional Coffee Table includes leg assembly, cross beams and one worksurface with a small 1.5" radius at each corner.
- Surface available in LP - Low Pressure laminate.
- Legs and cross beam are painted aluminum available in standard paint finishes.

PRODUCT CODE	PRICE LP	SIZE/INCHES			WEIGHT LBS	VOL FT ³
		H	W	D		
SCOCS2424	563	17	24	24	30.22	5.67
SCOCS3030	643	17	30	30	43.10	8.86

SCOCSL • Occasional Coffee Table, Square Top, Larger Radius



- Occasional Coffee Table includes leg assembly, cross beams and one worksurface with a larger 9" radius at each corner.
- Surface available in LP - Low Pressure laminate.
- Legs and cross beam are painted aluminum available in standard paint finishes.

PRODUCT CODE	PRICE LP	SIZE/INCHES			WEIGHT LBS	VOL FT ³
		H	W	D		
SCOCSL2424	563	17	24	24	29.11	5.67
SCOCSL3030	643	17	30	30	41.99	8.86

SCOCC • Occasional Coffee Table, Racetrack Top

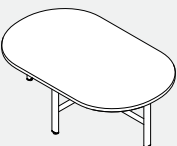

- Occasional Coffee Table includes leg assembly, cross beams and one racetrack worksurface.
- Surface available in LP - Low Pressure laminate.
- Legs and cross beam are painted aluminum available in standard paint finishes.

PRODUCT CODE	PRICE LP	SIZE/INCHES			WEIGHT LBS	VOL FT ³
		H	W	D		
SCOCC2442	676	17	24	42	42.78	9.93
SCOCC3048	777	17	30	48	57.13	14.18

SCLCC • Laptop Table, Racetrack Top, Wheel and Foot Base

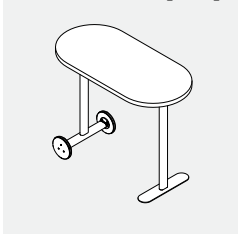

<ul style="list-style-type: none"> Laptop Table includes leg assembly and two wheels with rubber trim, one leg assembly with a foot and one racetrack worksurface. Two bag hooks included, one on the exterior of each leg, mounted just under the surface for easy access. Each bag hook accepts up to 10 lbs, and painted to match the legs. Legs, beams and hook are painted aluminum available in standard paint finishes. Wheel insert is painted to match the legs and beams. Surface available in LP - Low Pressure laminate. 	PRODUCT	PRICE	SIZE/INCHES			WEIGHT	VOL
	CODE	LP	H	W	D	LBS	FT ³
	SCLCC1633	901	26	33	16	25.60	6.51

SCLCB • Laptop Table, Racetrack Top, Foot Base



<ul style="list-style-type: none"> Laptop Table includes two leg assemblies a foot and one racetrack worksurface. Two bag hooks included, one on the exterior of each leg, mounted just under the surface for easy access. Each bag hook accepts up to 10 lbs, and painted to match the legs. Legs and beams are painted aluminum available in standard paint finishes. Surface available in LP - Low Pressure laminate. 	PRODUCT	PRICE	SIZE/INCHES			WEIGHT	VOL
	CODE	LP	H	W	D	LBS	FT ³
	SCLCB1633	516	26	33	16	23.85	6.51

SCLTC • Laptop Table, Rectangular Top, Small Radius, Wheel and Foot Base

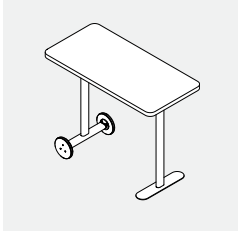

<ul style="list-style-type: none"> Laptop Table includes leg assembly and two wheels with rubber trim, one leg assembly with a foot and one rectangular worksurface with a small 1.5" radius at each corner. Two bag hooks included, one on the exterior of each leg, mounted just under the surface for easy access. Each bag hook accepts up to 10 lbs, and painted to match the legs. Legs and beams are painted aluminum available in standard paint finishes. Wheel insert is painted to match the legs and beams. Surface available in LP - Low Pressure laminate. 	PRODUCT	PRICE	SIZE/INCHES			WEIGHT	VOL
	CODE	LP	H	W	D	LBS	FT ³
	SCLTC1633	901	26	33	16	27.64	6.51

SCLTB • Laptop Table, Rectangular Top, Base

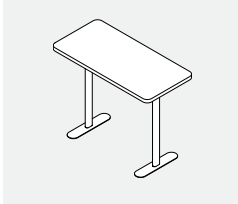

<ul style="list-style-type: none"> Laptop Table includes two leg assemblies a foot and one rectangular worksurface with a small 1.5" radius at each corner. Two bag hooks included, one on the exterior of each leg, mounted just under the surface for easy access. Each bag hook accepts up to 10 lbs, and painted to match the legs. Legs and beams are painted aluminum available in standard paint finishes. Surface available in LP - Low Pressure laminate. 	PRODUCT	PRICE	SIZE/INCHES			WEIGHT	VOL
	CODE	LP	H	W	D	LBS	FT ³
	SCLTB1633	516	26	33	16	25.88	6.51

Global offices in Canada

Head Office

560 Supertest Road
Toronto, Ontario
M3J 2M6
T (416) 650-6500

Toronto Sales Office

1350 Flint Road
Toronto, Ontario
M3J 2J7
T (416) 661-3660

Moncton

268 Coverdale Road
Riverview, New Brunswick
E1B 3J2
T (506) 858-8383

Showrooms

Calgary

237 8 Avenue SE, Suite 302
Calgary, Alberta
T2G 5C3
T (403) 250-7770

Montreal

1010 Sainte-Catherine Street West
Mezzanine 2
Montreal, Quebec
H3B 1E7T
T (514) 866-4331

Ottawa

251 Laurier Avenue West, Suite 400
Ottawa, Ontario
K1P 5J6
T (613) 234-2881
Please call ahead to book an appointment.

Edmonton

10158 103 Street NW, Suite 201
Edmonton, Alberta
T5J 0X6
T (780) 444-8922

Toronto

1350 Flint Road
Toronto, Ontario
M3J 2J7
T (416) 661-3660

Vancouver

675 West Hastings Street, Suite 1000
Vancouver, British Columbia
V6B 1N2
T (604) 432-1701

Halifax

1061 Marginal Road, Suite 120
Halifax, Nova Scotia
B3H 4P7
T (902) 422-7434

Toronto - The Blueprint

(MetroCentre)
200 Wellington Street West, Suite 1602
Toronto, Ontario
M5V 3C7

Winnipeg

111 Lombard Avenue, Suite 220
Winnipeg, Manitoba
R3B 0T4
T (204) 925-3350

